

Data sheet | Item number: 286-368

Relay module; Nominal input voltage: 24 VDC; 1 break contact; Limiting continuous current: 5 A; Red status indicator; Module width: 10 mm

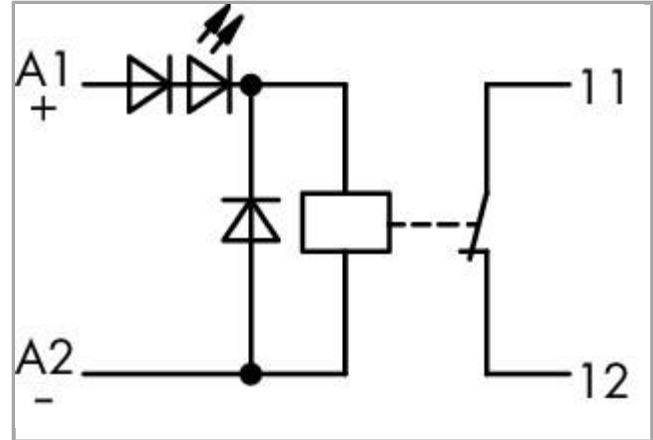

286-368

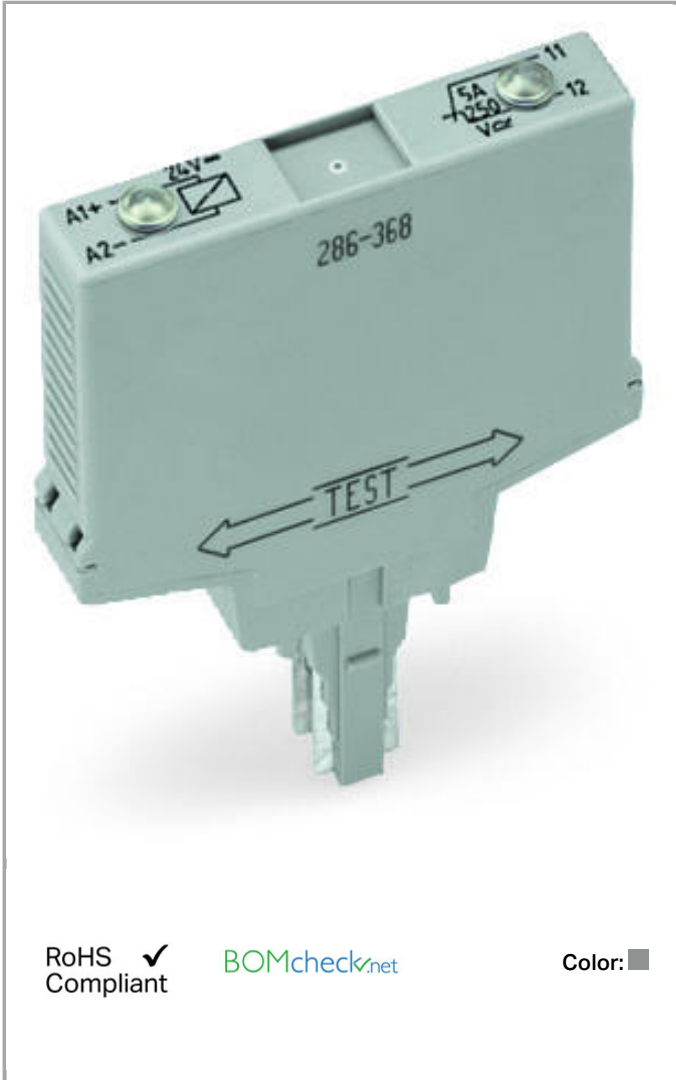

RoHS Compliant

[BOMcheck.net](https://www.bomcheck.net)

Color: ■

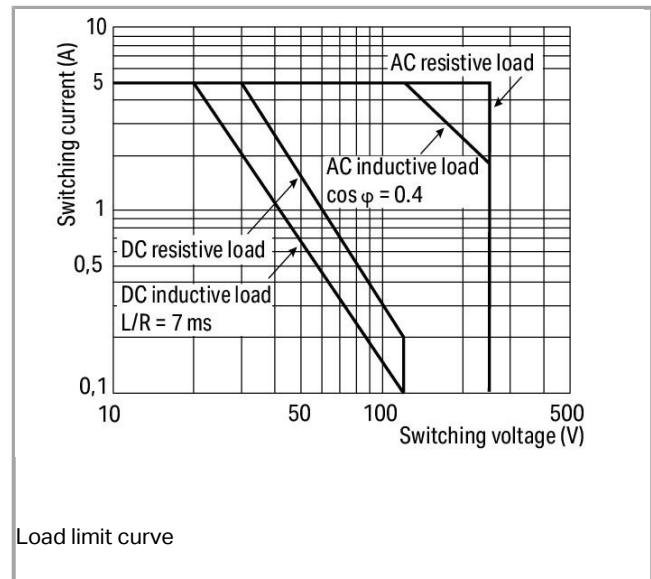
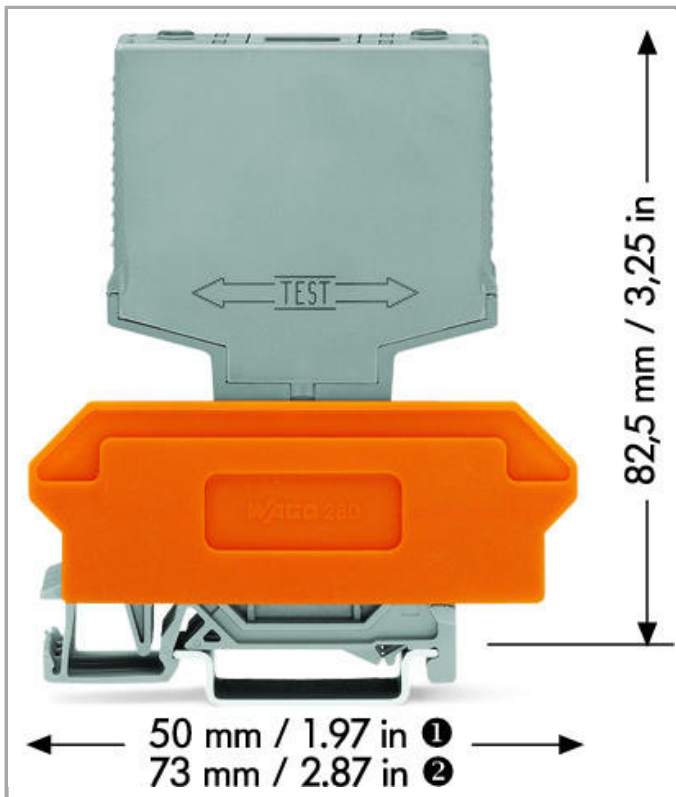

Data

Technical Data

Control circuit

Nominal input voltage U_N	DC 24 V
Input voltage range	$\pm 10\%$
Nominal input current at U_N	20.4 mA

Load circuit:

Number of break contacts/switch off contacts	1
Contact material (relay)	AgNi
Limiting continuous current	5 A
Max. switching voltage	AC 250 V
Max. switching power (resistive)	AC 1,250 VA
Pull-in time (typ.)	10 ms
Drop-out time (typ.)	4 ms
Bounce time (typ)	3 ms
Electrical life (N.O.; resistive load; 23 °C)	50×10^3 switching operations
Mechanical life (N.O.; resistive load; 23 °C)	5×10^6 switching operations

Signaling

Status indication	LED red
-------------------	---------

Safety and protection:

Rated voltage	250 V
Rated impulse voltage	4 kV
Pollution degree	2
Dielectric strength, control/load circuit (AC, 1 min)	4 kVrms
Protection class	IP20

Geometrical Data

Width	10 mm / 0.394 inch
Height from upper-edge of DIN-35 rail	82.5 mm / 3.248 inch
Depth	52 mm / 1.654 inch

Mechanical data

Type of mounting	Pluggable module for carrier terminal blocks
------------------	--

Material Data

Color	gray
Fire load	0MJ
Weight	19.075 g

Environmental Requirements

Pollution degree	2
Surrounding air (operating) temperature at U_N	-25 ... 40 °C
Surrounding air (storage) temperature	-25 ... 70 °C

Standards and specifications



Standards/specifications	EN 60664-1
--------------------------	------------

Commercial data









Product Group	6 (Interface Electronics)
Country of origin	DE
GTIN	4045454384036
Customs Tariff No.	85364900990

Compatible products

General accessories

	Item no.: 280-608 Terminal block for pluggable modules; 8-pole; with 4-conductor terminal blocks; with orange separator; for DIN-rail 35 x 15 and 35 x 7.5; 2.5 mm ² ; CAGE CLAMP®	280-608
	Item no.: 280-618 Terminal block for pluggable modules; 4-pole; with 2-conductor terminal blocks; with orange separator; for DIN-rail 35 x 15 and 35 x 7.5; 2.5 mm ² ; CAGE CLAMP®	280-618
	Item no.: 280-762 Terminal block for pluggable modules; 8-pole; with 4-conductor terminal blocks; with marker carrier; with orange separator; for DIN-rail 35 x 15 and 35 x 7.5; 2.5 mm ² ; CAGE CLAMP®	280-762

Marking accessories

	Item no.: 209-701 WSB marking card; as card; not stretchable; plain; snap-on type	209-701
	Item no.: 209-701/000-002 WSB marking card; as card; not stretchable; plain; snap-on type	209-701 /000-002
	Item no.: 209-701/000-005 WSB marking card; as card; not stretchable; plain; snap-on type	209-701 /000-005
	Item no.: 209-701/000-006 WSB marking card; as card; not stretchable; plain; snap-on type	209-701 /000-006
	Item no.: 209-701/000-007 WSB marking card; as card; not stretchable; plain; snap-on type	209-701 /000-007
	Item no.: 209-701/000-012 WSB marking card; as card; not stretchable; plain; snap-on type	209-701 /000-012
	Item no.: 209-701/000-017 WSB marking card; as card; not stretchable; plain; snap-on type	209-701 /000-017
	Item no.: 209-701/000-023 WSB marking card; as card; not stretchable; plain; snap-on type	209-701 /000-023
	Item no.: 209-701/000-024 WSB marking card; as card; not stretchable; plain; snap-on type	209-701 /000-024



Downloads

Documentation

Bid Text

286-368 Relaisbaustein	Jan 22, 2016	doc 26.6 kB	Download
---------------------------	--------------	----------------	----------

Additional Information

Disposal; Electrical and electronic equipment, Packaging	V 1.0.0	pdf 265.8 kB	Download
--	---------	-----------------	----------

CAD/CAE - Smart Data

CAD data

3D Download 286-368		URL	Download
---------------------	--	-----	----------

Subject to changes.
